

INSTRUCTION FOR CORRECT INSTALLATION AND USE

Fixture: **CEILING MOUNTING CHANDELIER**

Model: **DIANA 4**

Article: 0112

TECHNICAL DATA

Power supply voltage:	220-230V ~ 50Hz 110-120V ~ 50Hz
Tolerance:	± 10%
Fattore di potenza (cos ϕ):	See bulbs data
Corrente assorbita:	See bulbs data
Room temperature	25°C ± 10°C
International Protection:	20
Light Bulbs:	4X G9 MAX 10W LED
Class:	II
Installation:	Ceiling Mounting

WEIGHT: **5 KG**

Light fixture for indoor use only - (IP20)

Safety Warnings

The safety of this appliance is guaranteed only if the following instructions are adhered to; therefore, it is necessary to follow them closely and completely. Retain these instructions for reference.

- This light fixture is safe only if installed by a qualified electrician, respecting its intended use and observing the rules of maintenance. Substitution of parts should be done only by a qualified electrician, respecting current regulations and using materials of equal electrical, thermal, and mechanical characteristics.
- Before installing the light fixture, inspect for any damage: in the case of defects or any doubts thereof, please contact the dealer. Defective parts and/or light bulbs need to be immediately replaced; to protect against electrocution and to reduce the risk of fire, before turning on the switch, check that all of the bulbs are inserted correctly and that they do not exceed the recommended wattage indicated on the product label; pay particular attention while changing the bulbs, as their surfaces can be very hot.
- Check that the power supply voltage is equal to that which is indicated on the product label.
- Do not install light bulbs that exceed the indicated wattage.
- Clean only the external surfaces, reflectors and covers. Water or other liquids must not come into contact with the electrical wiring or with the compartments which contain these elements.
- Do not leave the packing materials (boxes, plastic bags, Styrofoam, etc.) within the reach of children as they can be dangerous (risk of suffocation, abrasions, etc.).
- The light fixture is not intended for in-series installation with other lighting fixtures, etc.
- If the external power cable or cord of this light fixture is damaged, it must be replaced only by the manufacturer, by their service agents, or by an equivalent qualified electrician, in order to avoid potential danger.
- Free-standing lighting fixtures must have adequate stability. The fixture must not tip over. It is recommended to always keep it on a perfectly level and stable surface.
- This product conforms to the Low Voltage Directive of the European Parliament (2014/35/EU).
- The manufacturer does not take any responsibility for installations that do not conform with current regulations, or for assembly and maintenance that does not respect these safety warnings and instructions for use.

CLEANING INSTRUCTIONS

Use only a soft cloth to clean the appliance, dampened with water and soap or mild cleanser.

Warning: do not use alcohol or other solvents.

INSTRUCTION FOR CORRECT INSTALLATION AND USE

The crossed-out bin symbol shown on the label indicates that the product, at the end of its useful life, must be treated separately from household waste, must be taken to a separate collection center for electrical and electronic equipment or returned to the retailer. The user is responsible for providing the appliance at the end of its life to the appropriate collection facilities, under penalty of penalties provided for by current waste legislation.

Adequate separate collection for the subsequent start-up of the decommissioned appliance for recycling, treatment and environmentally compatible disposal helps to avoid possible negative effects on the environment and health and favors the recycling of the materials of which the product is made.

For more detailed information regarding the collection systems available, contact the local waste disposal service or the shop where the purchase was made.

Producers and importers fulfill their responsibility for recycling, treatment, environmentally compatible disposal both directly and by participating in a collective system.



- Retain a copy of these instructions to the maintenance manager for consultation, knowledge of the warnings and for proper and regular maintenance.



- Before opening the device to replace the bulb, disconnect the power from the main electrical system.



- Before starting the assembly, at each check and maintenance, disconnect the power supply using the main switch of the electrical system.

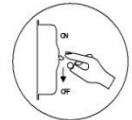

- If this symbol is on the label, the fixture must not be mounted on a normally flammable surface.



- It certifies the conformity of the product with the provisions of the Community directives.



- Fixture "For internal use only".



- Class 2 fixtures (IEC 60417-5172 (2003-02)).

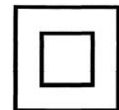

- Fixtures not suitable for being covered with thermally insulating material



INSTRUCTION FOR CORRECT INSTALLATION AND USE

ATTENTION! Use only LED bulbs.

Installation

Ceiling-mounted light fixtures must be installed by a qualified licensed electrician, respecting its intended use and observing the rules of maintenance.

Substitution of parts should be done only by a qualified electrician, respecting current regulations and using materials of equal electrical, thermal, and mechanical characteristics.

- If the ceiling-mounted light fixture is fitted with a hook, hang the light fixture on a hook anchored to the ceiling which has been tested to hold at least 4 times the weight of the light fixture (ceiling anchor hook not included).
- Connect the wires from the light fixture (NEUTRAL, GROUND/EARTH, HOT/LIVE) to the corresponding power supply wires (230V ~ 50Hz) by way of the block connector (fig.1) or clamps (fig.2) present inside the base/canopy.
- Use the supplied plastic sheath tubing to protect the wires coming from the electrical power supply system. Close the block connector, or alternatively, the clamps, with a click.

➤ **EUROPE / ASIA / RUSSIA**

Weight: 5 KG

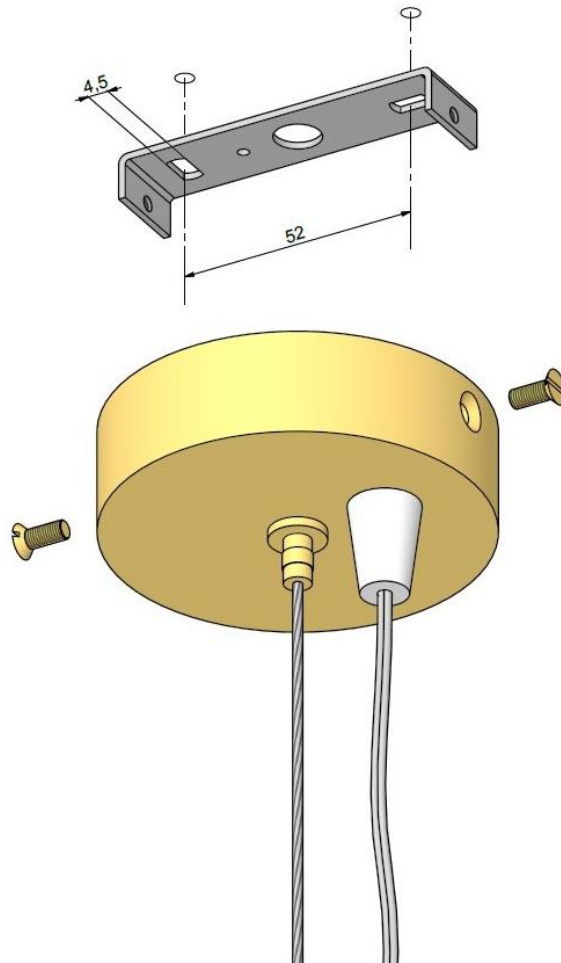

INSTRUCTION FOR CORRECT INSTALLATION AND USE

 **USA**

Fix the lamps to the J-box through the plate in the photo.

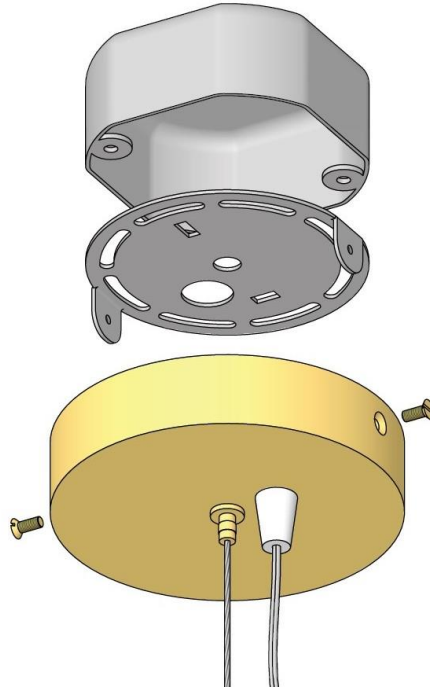

- Insert the light bulb (not exceeding the indicated wattage) into the base, then tighten the spring to insert the glass.

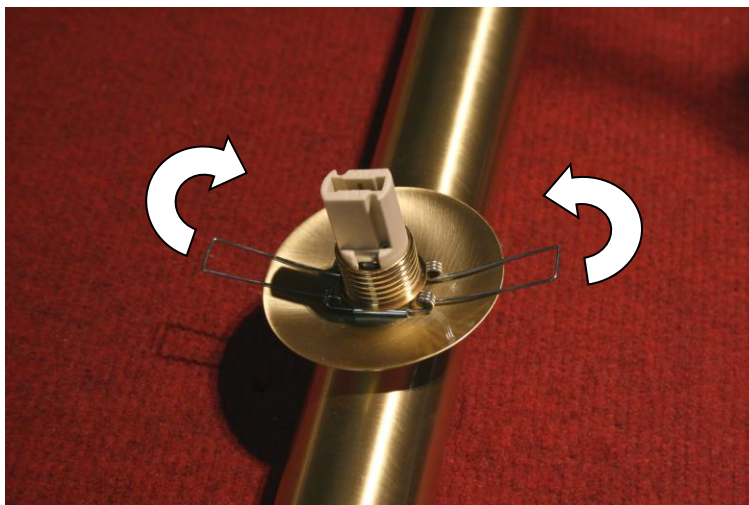

INSTRUCTION FOR CORRECT INSTALLATION AND USE

- When installing or changing the light bulb, pay close attention to the base type and the maximum wattage as indicated by the manufacturer on the label attached to the base of the appliance. (Label showing the rated voltage and wattage is located on the lamp base cover.)
- Once the maintenance is completed, check that every part of the light fixture is free from damage or metal, electrical, mechanical (mounting, fasteners) and/or stability hazards.
- Restore power with the main switch of the electrical system.

ATTENTION! Use "DIMMABLE" light bulbs if there is a dimmer switch/knob installed on either the light fixture or the main electrical system.

